

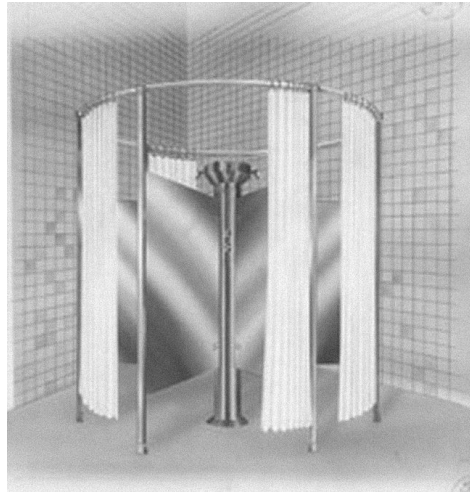

## Shower-Ware® 600DS Series

Diana Circular Privacy Compartments for Classic and Capital Column Showers, Two to Six Stations



741-B11-DS-D

Fixture May Show Some Available Options

Please visit [www.acorneng.com](http://www.acorneng.com) for most current specifications.

### Diana Circular Privacy Compartments for Classic and Capital Column Showers, Two to Six Stations

- DS Stainless Steel Circular Privacy Compartments provide a bathing area for each shower station.

Hardware for each compartment includes posts, headrails, brackets, and escutcheons. All hardware is vandal-resistant.

Curtains are white Herculite® material.

Panels for - DS are constructed using structural honeycomb core firmly cemented to the stainless steel panels. Formed molding interlocks panel edges under tension. Corners are welded and polished.

Posts are provided with a jackscrew type leveling system which is concealed by an escutcheon.

Shower Compartments are available with suffix - HC Handicapped Shower option. Folding seat is not furnished with this combination. The following should be added to the base specification for Classic and Capital Column Showers, Two to Six Stations.

#### BRIEF SPECIFICATION

Provide and install Acorn Diana Circular Privacy Compartments (example - DS Stainless Steel) as shown on contract drawings.

#### DETAILED SPECIFICATION

Provide and install Acorn Diana Circular Privacy Compartments (specify type) as shown on contract drawings. Provide white Herculite® shower curtain with chrome-plated hooks for each Privacy Compartment and Dressing Compartment entrance. Privacy Compartments are available with suffix - HC Handicapped Shower option. Folding seat is not furnished with this combination.



BASE MODEL NUMBER (Must Specify)

- DS Circular Privacy Compartments (Stainless Steel)

Product Options

-D Soap Dish

SHOWER TYPE (Must Specify)

- 600 Series Classic

- 700 Series Capital

Please visit [www.acorneng.com](http://www.acorneng.com) for most current specifications.

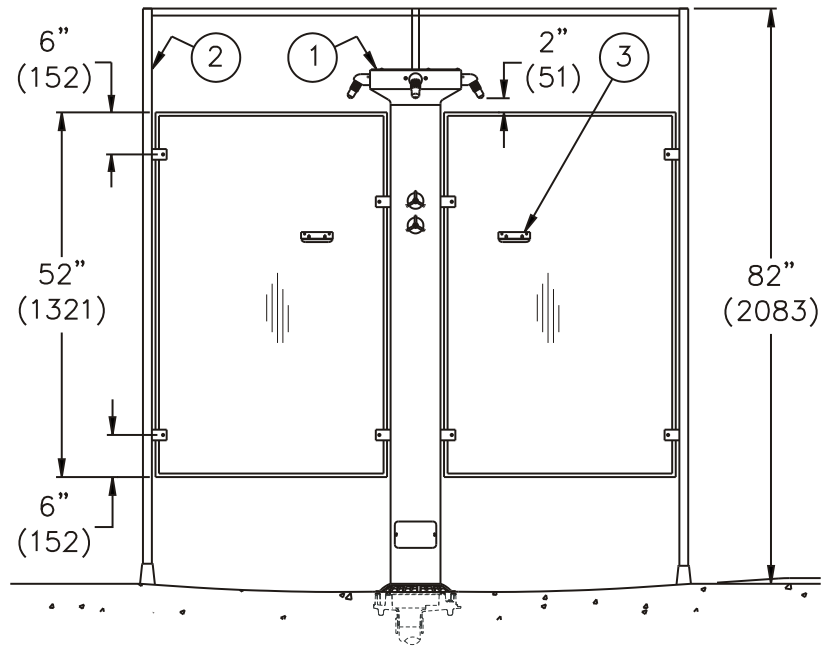
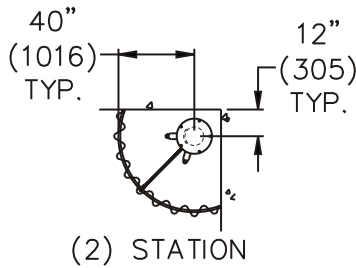
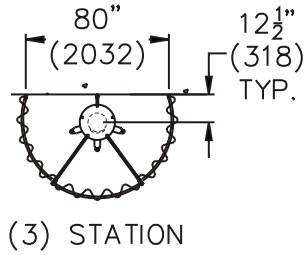
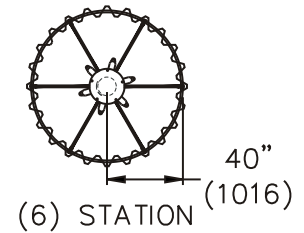
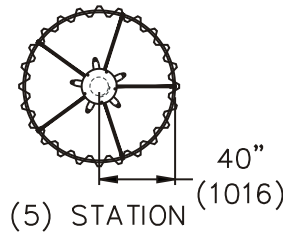
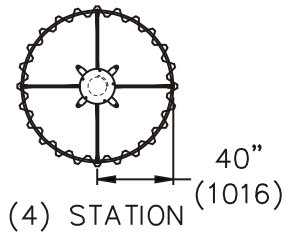

MODEL# 700-DS SERIES

NOTES:

- 1. Capital Column Shower.
- 2. Post/Pilaster.
- 3. Optional -D Soap Dish.

Important: Installation instructions and current rough-in are furnished with each fixture. Do not rough in without certified dimensions. Dimensions are subject to manufacturer's tolerance of plus or minus 1/4" and change without notice. Acorn assumes no responsibility for use of void or superseded data. © Copyright 2007 Acorn Engineering Company	
<p style="text-align: center;"><b>Selection Summary</b></p> <p>Model No. &amp; Option _____</p> <p>Quantity _____</p>	<p style="text-align: center;"><b>Approved for Manufacturing</b></p> <p>Company _____ Title _____</p> <p>Signature _____ Date _____</p>

S.600DS

Revised: 02/23/09