

SHOWER BASES

RECOMMENDED CLEANING & MAINTENANCE PROCEDURES FOR TERRAZZO-WARE SHOWER BASES

1. Regular Cleaning

To maintain the original terrazzo appearance, clean regularly with a liquid detergent such as Joy, Liquid Ajax or Spic and Span (for the latter, prepare a solution containing 1/2 cup of Spic and Span in a gallon of water). Scrub with a stiff bristled, non-metallic scrub brush and then rinse thoroughly.

NOTE: Do not use any acid, e.g., muriatic or cleaning agents that contain acid.

2. Special or Unusual Conditions

a. Scum on surface caused by soap, make-up, etc:

Use a cleaning powder, such as Ajax, plus lots of elbow grease.

b. Surface cleaning:

Heel marks, plaster, etc. may require abrasive removal. This can be done with a wet emery cloth. If emery cloth is ineffective, use an 80 to 100 grit aluminum oxide coated paper. Abrasive cloth or paper will result in a very faint grinding away of the base surface.

c. Penetrated stains:

Stains such as caused by oil, putty, etc., may be removed by scouring with a cleanser and then soaking floor overnight—if need be—with a commercial bleach such as Linco, etc.



Acorn Engineering Company

800-488-8999 or 626-336-4561

FAX 626-961-2200

P.O. BOX 3527 • CITY OF INDUSTRY, CA 91744-0527 (U.S.A.)

INSTALLATION INSTRUCTIONS



ACORN ENGINEERING
COMPANY

TERRAZZO-WARE Shower Bases

800-488-8999 or 626-336-4561

FAX 626-961-2200

P.O. BOX 3527 • CITY OF INDUSTRY, CA 91744-0527 (U.S.A.)



Shower Bases

1 HANDLING

Carefully remove **Shower Base** from carton at installation point. Avoid placing **Shower Base** on its edge. (This precaution will prevent damage to corners of **Shower Base**.)

METHOD FOR CHECKING FACE OF Shower Base FOR TRANSPORTATION DAMAGE:

- A. Wipe face of **Shower Base** with a wet cloth. (Water).
- B. When the water evaporates, any slight crack in the **Shower Base** will be noticeable.

REMOVE SHOWER BASE CAREFULLY FROM CARTON

REMOVE PACKAGING WITH CARE

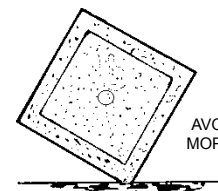
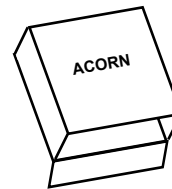

AVOID STANDING MOP SINK ON END

2 LEVELING

Level **Shower Base** carefully. For proper installation, establish a 1/4" clearance between **Shower Base** and the walls. A layer of mortar or sand must be placed in area where the **Shower Base** is to be installed. This procedure is recommended in order to support **Shower Base** should the sub floor be uneven. Grout should be exposed along edges.

NOTE: Mortar or sand must cover the entire area between **Shower Base** and building floor.

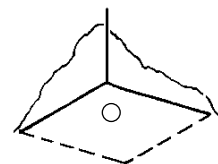
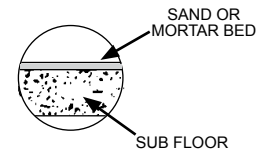
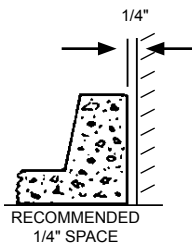

DOTTED AREA IS FOR MOP SINK



GROUT EXPOSED SIDES

3 WARNING!

DO NOT DROP MOP SINK OVER EXPOSED PIPE.

It is advisable to remove drain pipe and set **Shower Base** in place. Insert pipe through drain in **Shower Base** back into "P" trap. Tighten with an internal pipe wrench.

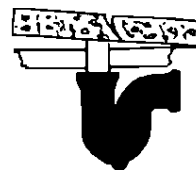

DO NOT DROP ON PIPE

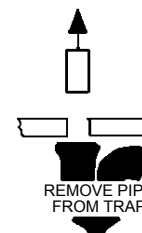

REMOVE PIPE FROM TRAP

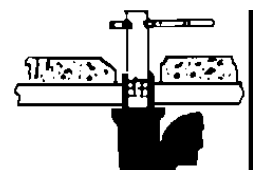

REINSERT PIPE AND TIGHTEN WITH AN INTERNAL WRENCH

INSTALLATION INSTRUCTIONS



ACORN ENGINEERING
COMPANY

TERRAZZO-WARE Shower Bases

800-488-8999 or 626-336-4561

FAX 626-961-2200

P.O. BOX 3527 • CITY OF INDUSTRY, CA 91744-0527 (U.S.A.)



Shower Bases

4 RECOMMENDED PROCEDURE.

INSTALLATION INSTRUCTIONS:

1. Cut drain pipe to extend 1-3/8" into drain body. Drain pipe should be even with top of gasket when installation is completed. Position **Shower Base** over 2" waste pipe making sure that pipe is centered in drain body.
2. Lubricate gasket with soap solution and stretch over 2" pipe with letters facing up.
3. Push gasket as far as possible into joint.
4. Using a hammer and caulking tool or 1/4" X 3/4" X 6" piece of wood instead of a caulking tool, work around the gasket with a series of blows and gradually drive gasket into drain body until it bottoms. Drain pipe should be even with the top of gasket.
5. Test connection before covering or concealing. To test: plug 2" drain and fill receptor with water. Check for leaks. **This must be done before finishing walls.**

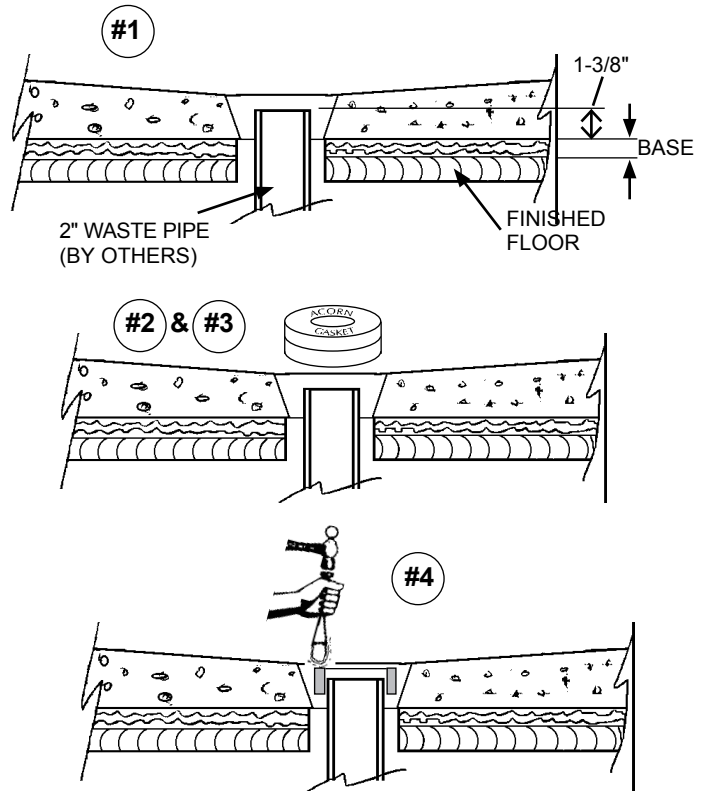

ALTERNATE PROCEDURE

- A. TAMP OAKUM TO 5/8" DEPTH.
- B. POUR MOLTEN LEAD.
- C. TAMP LEAD CAREFULLY.

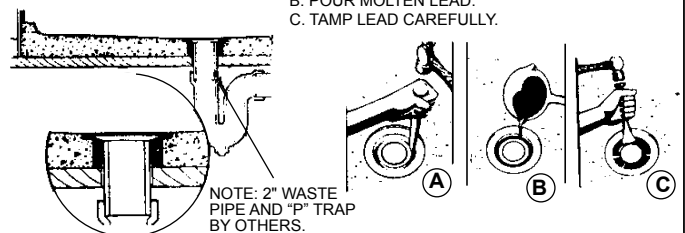

5 WARNING!

MODELS WITH TILING FLANGE OPTIONS:

- A. Do not let rough wall material overlap flange.
- B. Do not attach flange to building wall.
- C. Let finished wall (tile, etc.) overlap and rest on shoulder.

