

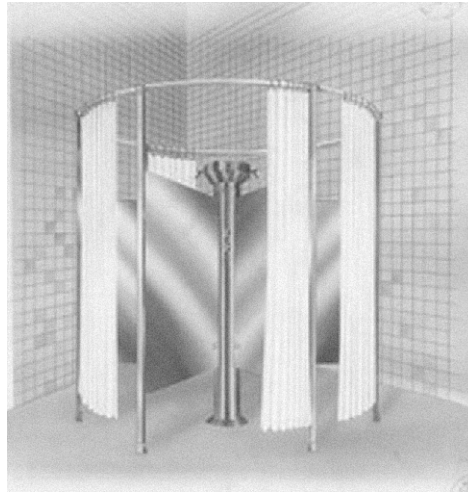

## Shower-Ware® 600DS Series

Diana Circular Privacy Compartments for Classic and Capital Column Showers, Two to Six Stations



741-B11-DS-D

Fixture May Show Some Available Options

Please visit [www.acorneng.com](http://www.acorneng.com) for most current specifications.

### **Diana Circular Privacy Compartments for Classic and Capital Column Showers, Two to Six Stations**

- **DS** Stainless Steel Circular Privacy Compartments provide a bathing area for each shower station.

**Hardware** for each compartment includes posts, headrails, brackets, and escutcheons. All hardware is vandal-resistant.

**Curtains** are white Herculite® material.

**Panels for - DS** are constructed using structural honeycomb core firmly cemented to the stainless steel panels. Formed molding interlocks panel edges under tension. Corners are welded and polished.

**Posts** are provided with a jackscrew type leveling system which is concealed by an escutcheon.

**Shower Compartments** are available with suffix - HC Handicapped Shower option. Folding seat is not furnished with this combination. The following should be added to the base specification for Classic and Capital Column Showers, Two to Six Stations.

#### **BRIEF SPECIFICATION**

Provide and install Acorn Diana Circular Privacy Compartments (example - DS Stainless Steel) as shown on contract drawings.

#### **DETAILED SPECIFICATION**

Provide and install Acorn Diana Circular Privacy Compartments (specify type) as shown on contract drawings. Provide white Herculite® shower curtain with chrome-plated hooks for each Privacy Compartment and Dressing Compartment entrance. Privacy Compartments are available with suffix - HC Handicapped Shower option. Folding seat is not furnished with this combination.



**BASE MODEL NUMBER (Must Specify)**

-DS Circular Privacy Compartments (Stainless Steel)

**PRODUCT OPTIONS**

-D Soap Dish

**SHOWER TYPE (Must Specify)**

-600 Series Classic  
 -700 Series Capital

Please visit [www.acorneng.com](http://www.acorneng.com) for most current specifications.

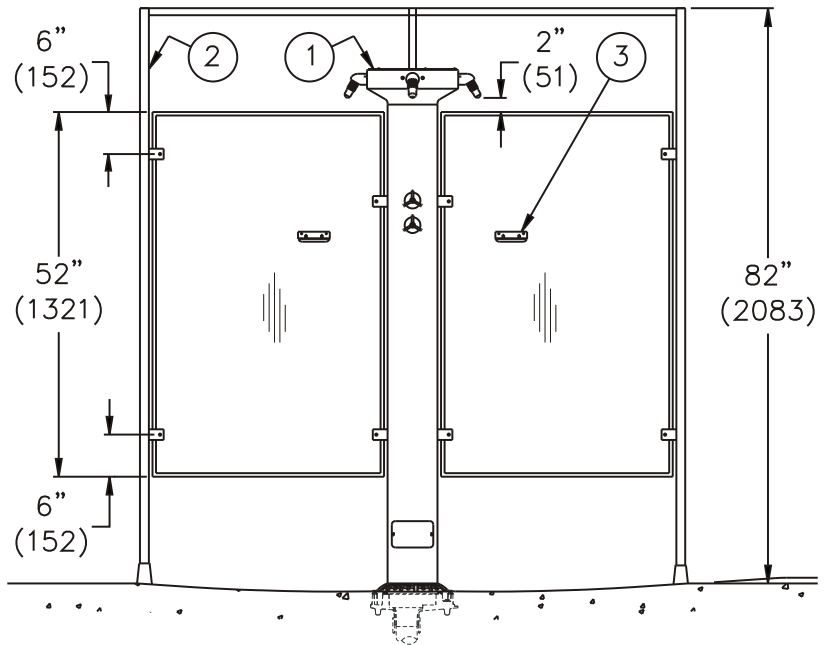
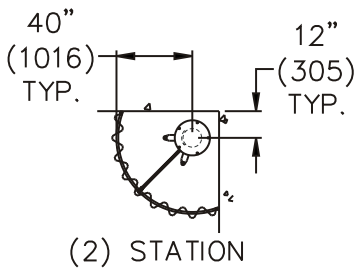
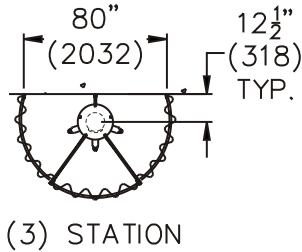
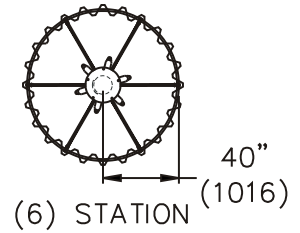
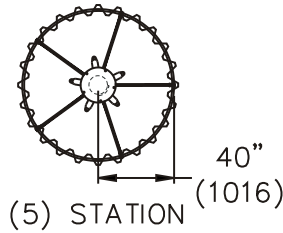
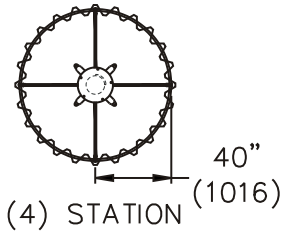

MODEL# 700-DS SERIES

**NOTES:**

1. Capital Column Shower.
2. Post/Pilaster.
3. Optional -D Soap Dish.

**WARNING:** Cancer and Reproductive Harm - [www.P65Warnings.ca.gov](http://www.P65Warnings.ca.gov)

<p><b>Important:</b> Installation instructions and current rough-in are furnished with each fixture. Do not rough in without certified dimensions. Dimensions are subject to manufacturer's tolerance of plus or minus 1/4" and change without notice. Acorn assumes no responsibility for use of void or superseded data. © Copyright 2007 Acorn Engineering Company</p>	
<p style="text-align: center;"><b>Selection Summary</b></p> <p>Model No. &amp; Option _____</p> <p>Quantity _____</p>	<p style="text-align: center;"><b>Approved for Manufacturing</b></p> <p>Company _____ Title _____</p> <p>Signature _____ Date _____</p>